

GENERATION

Access Solutions Edge Protection Installation Guide

LW/01.19



Generation UK Ltd
Trinity Street, Off Tat Bank Road,
Oldbury, West Midlands, B69 4LA
Tel: 0800 779 7113
Email: enquiries@generationuk.co.uk
www.generationuk.co.uk

GENERATION SCAFFOLDING AND ACCESS SUPPORT FOR CONSTRUCTION AND INDUSTRY

Generation is the largest UK supplier of access, scaffolding, safety and training products.

Our customer promise is to deliver the:

BEST QUALITY

We work in partnership with our suppliers to ensure we deliver consistent quality every time. We guarantee that our hire and sales products will meet and conform or exceed all statutory requirements and not let you down.

BEST AVAILABILITY

We have the largest available UK inventory of scaffolding, access and safety products. Our branch network and delivery fleet will ensure that we deliver what you need, when you need it.

BEST PARTNERSHIP

We provide a full range of engineering, design and business services to partner and work with our customers. Talk to us today about how we can help you to grow your business.

BEST PRICES

We use our position as the largest UK supplier of scaffolding products to negotiate the best rates for you. We guarantee you will get the best value products and service when you hire or buy from us.

Disclaimer

Whilst Generation (UK) Ltd has taken every reasonable effort to ensure the information contained within this publication is correct and complete at the time of printing, you should be aware that there will be periodical changes and Generation (UK) Ltd does not accept any liability for any inconvenience, loss or damage caused as a result of any inaccuracy or omission within this publication.

Copyright

No unauthorised reproduction of any images, text or other matter contained herein is permitted. All rights are expressly reserved, including copyright, design right, moral and patent rights (where applicable). We reserve the right to take legal action in respect of any infringement of said rights.

Contents

Access Solutions

Examples of Access Edge Protection Solutions.....	4
Lift Shaft Gate Installation Guide.....	5-8
Rapid Gate Socket Base and Top Fix Installation Guide	9-11
Correct Rapid Pin Installation Guide.....	12
EP Panels	13-20

A member of



Manufactured by



EXAMPLES OF ACCESS EDGE PROTECTION SOLUTIONS

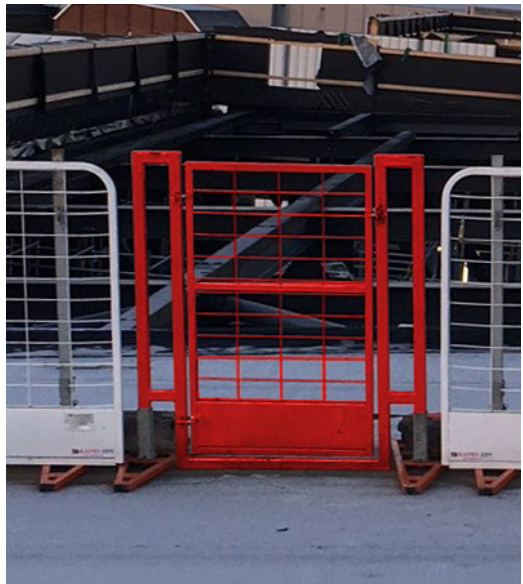
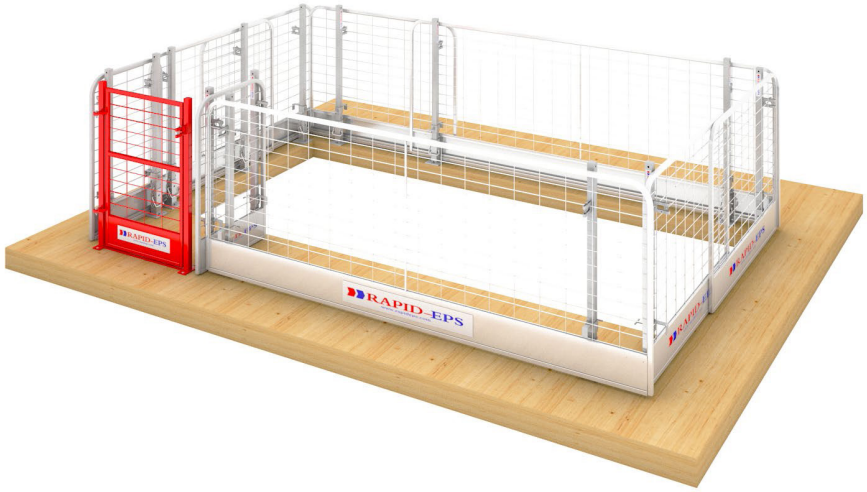

LIFT SHAFT GATE INSTALLATION GUIDE

450033
LIFT SHAFT
GATE



LIFT SHAFT GATE INSTALLATION GUIDE



STEP 1: Install rapid post or rapid post extra as set out in the rapid post and rapid post extra installation guide.

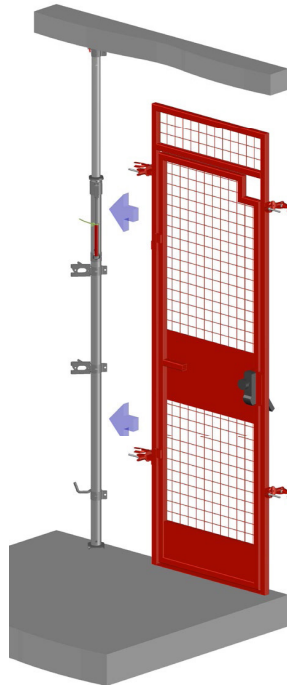

STEP 2: With the scaffold clamps open, position the gate onto the post.

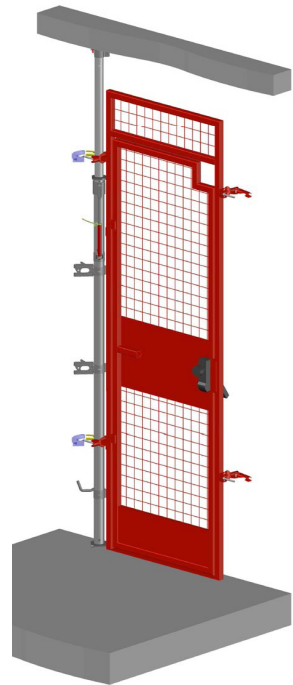

STEP 3: Close and tighten scaffold clamps.

Rapid posts or rapid post extras can be substituted for double height dual purpose stands. Please contact Generation for details regarding this product.

LIFT SHAFT GATE INSTALLATION GUIDE

IMPORTANT: Disassembly process must follow the instructions in reverse order. Improper installation or removal could result in serious injury or death.

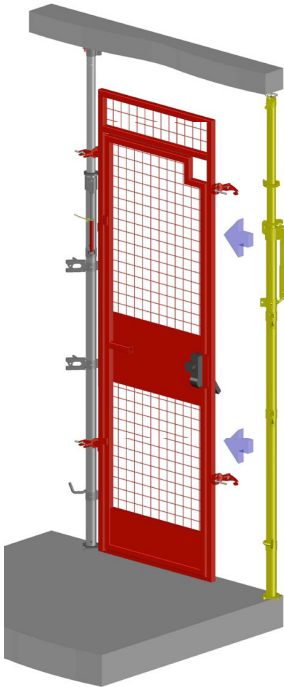

STEP 4: Place and install another rapid post or rapid post extra into open scaffold clamps at opposite side of gate.

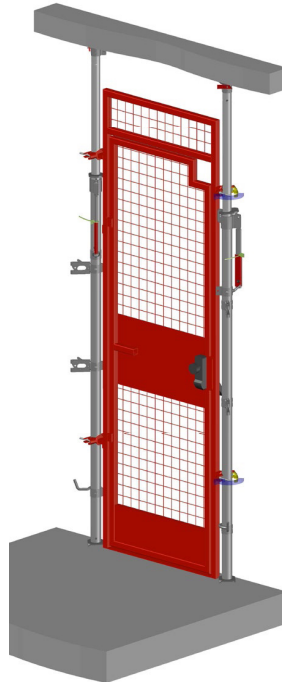

STEP 5: Close and tighten scaffold clamps.

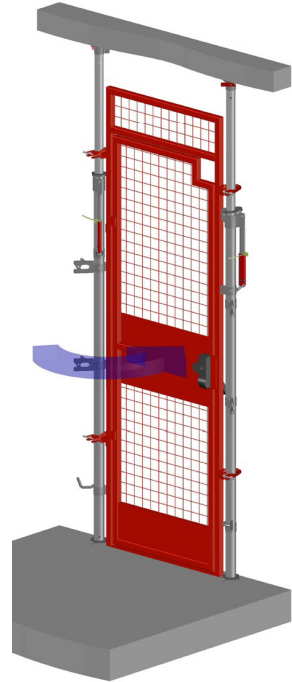

STEP 6: Ensure door is left closed and locked with the key removed when not in use.

Elevator access gates **must** be installed by **two** people. The area below installation **must** be closed off during installation.

TYPICAL LIFT SHIFT GATE & PANEL SET UPS

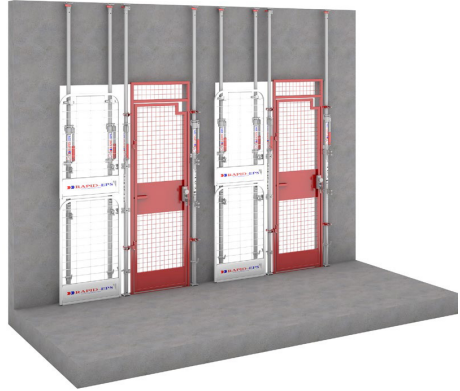
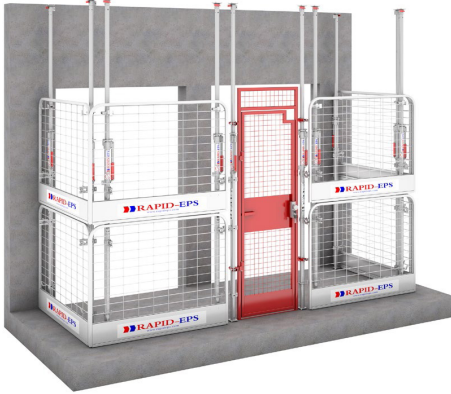

TYPICAL LIFT SHIFT GATE ENCLOSURE SET UP

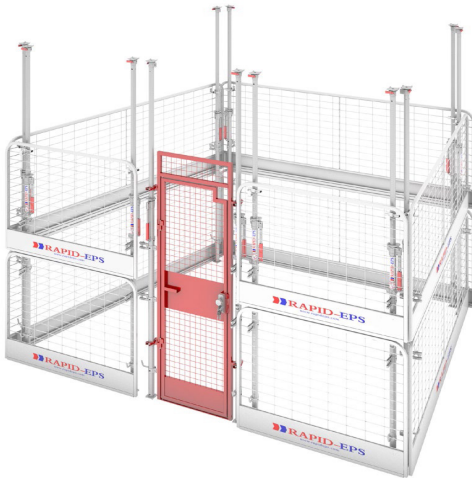

Please note that lift enclosures can be erected using rapid posts or rapid post extras on floor to ceiling heights up to 4.3m/14'1".

For floor to ceiling heights over 4.3m/14'1", 2.2m/7'2 1/2" dual purpose stands are required.

IMPORTANT: Disassembly process must follow the instructions in reverse order. Improper installation or removal could result in serious injury or death.

RAPID GATE SOCKET BASE AND TOP FIX INSTALLATION GUIDE



450032
RAPID GATE
SOCKET BASE

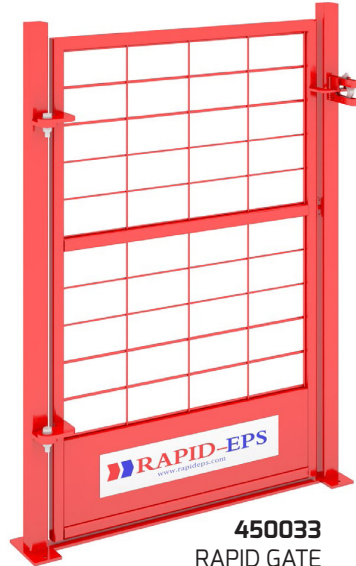

450033
RAPID GATE
TOP FIX

The rapid gate-socket base can be used with most rapid-eps products.
please contact Generation for details.

RAPID GATE - SOCKET BASE INSTALLATION GUIDE

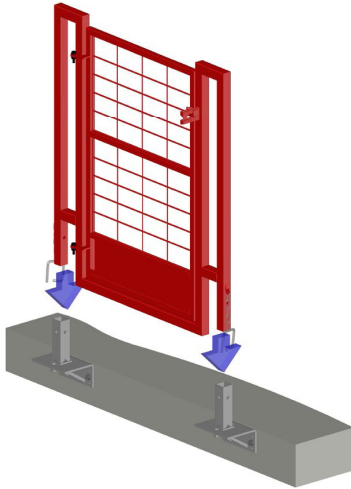

STEP 1: Place rapid gate socket bases.

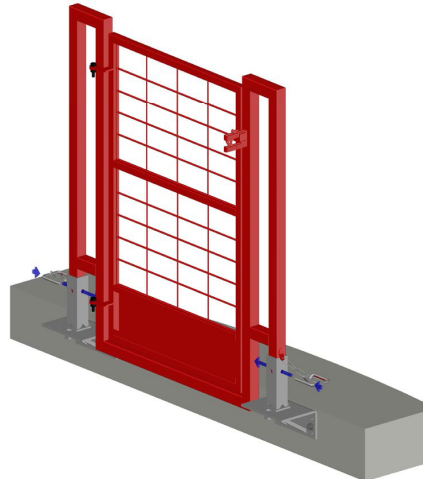

STEP 2: Push rapid pin through socket base and gate post.

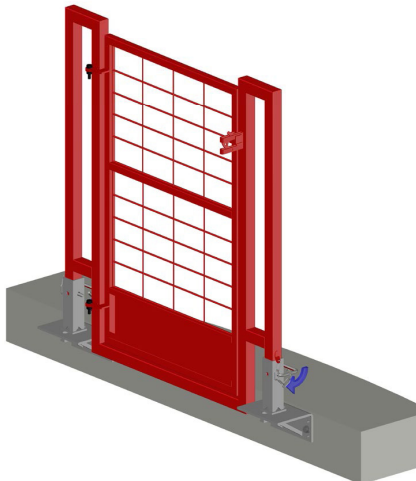

STEP 3: Rotate rapid pin into locked position

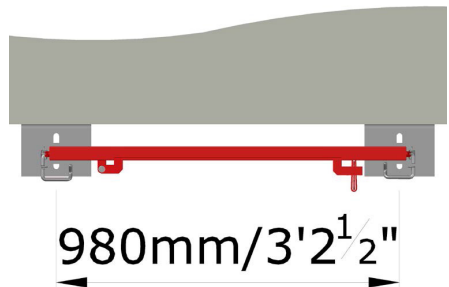

Socket bases used to hold the rapidgate should be set at 980mm/3'2 1/2" centers.

RAPID GATE - TOP FIX INSTALLATION GUIDE

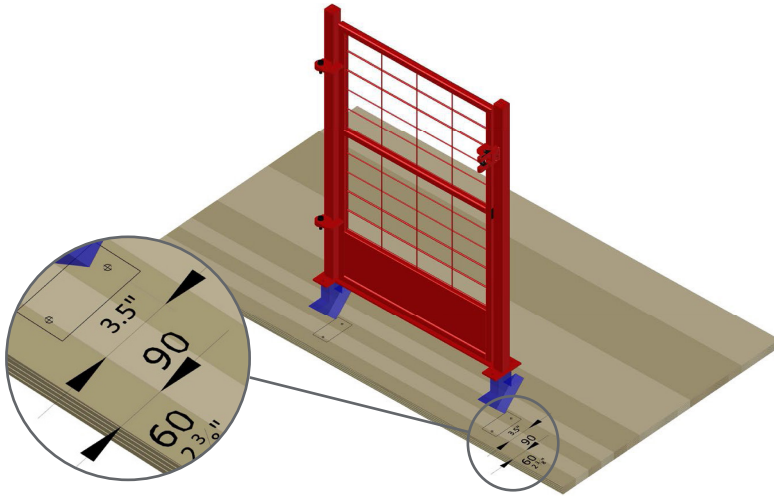

STEP 1: Place rapid gate a minimum of 60mm 2 1/2" back from the floor edge.

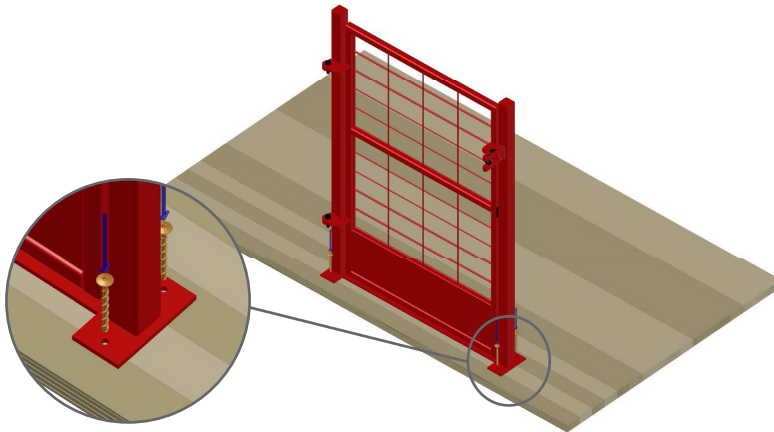

STEP 2: Fix rapid gate using 4no.ø8 x 80mm/31 4" heco topix screw.

CORRECT RAPID PIN INSTALLATION GUIDE

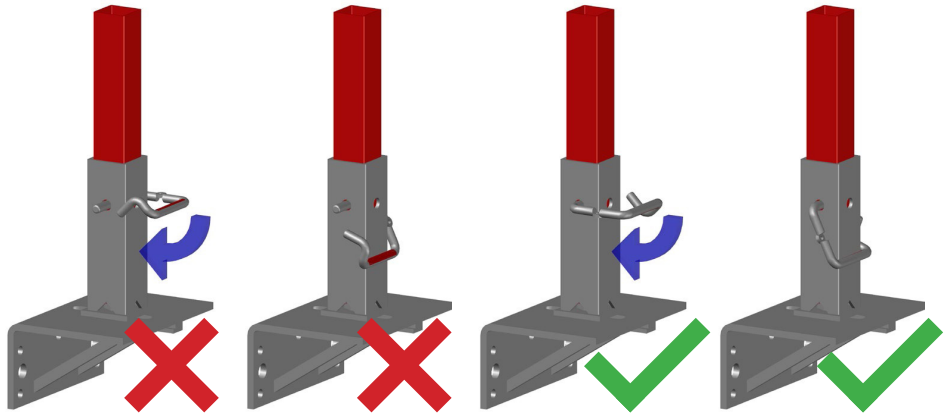

IMPORTANT NOTE: The rapid pin has a red “lock” sticker. This sticker should be hidden when pin is correctly installed.

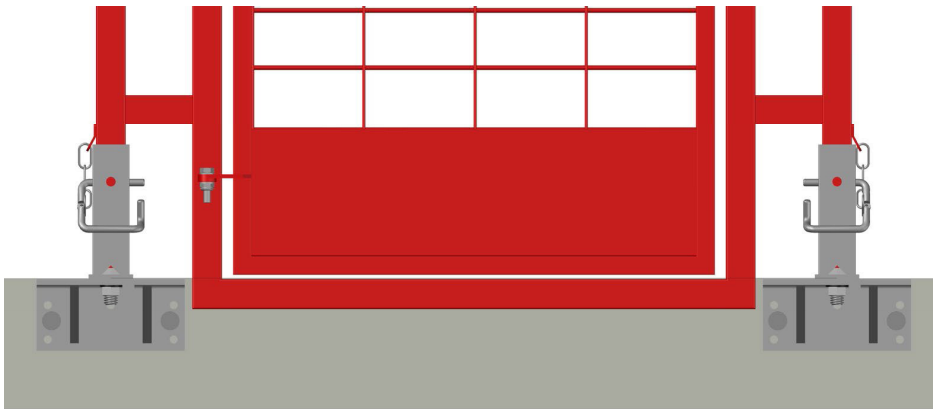

IMPORTANT NOTE: When properly installed, the base of the access gate should sit below slab level.

IMPORTANT: Disassembly process must follow the instructions in reverse order. Improper installation or removal could result in serious injury or death.

EP PANELS INSTALLATION GUIDE

450006
Half Panel
1400mm/4'7"
12kg/26.5lbs

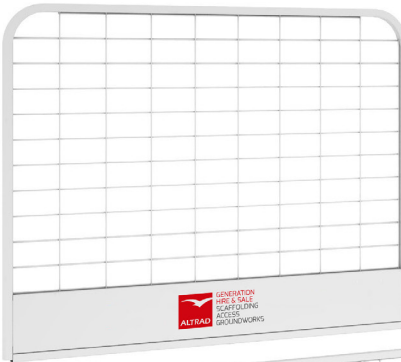

450064
Quarter panel
655mm/2'2"
9.5kgs/21lbs

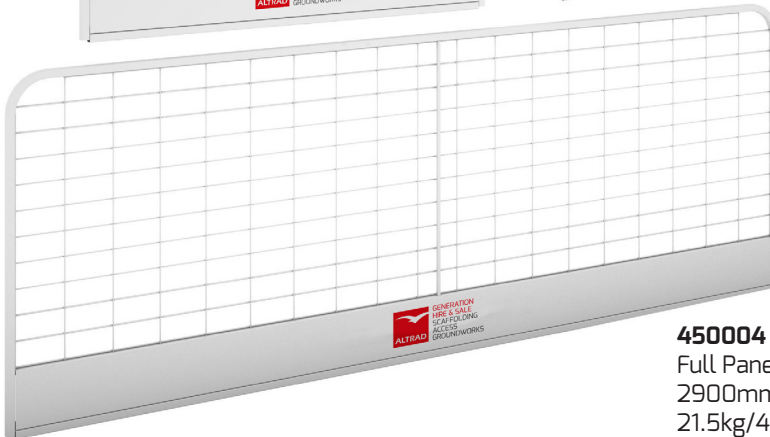
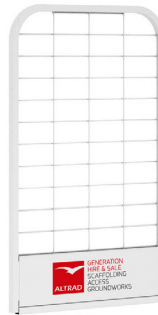

450004
Full Panel
2900mm/9'6"
21.5kg/47lbs

SINGLE PANEL INSTALLATION GUIDE

For double height panels or higher, please see overleaf.

Panel placement : RAPID-POST & EXTRA

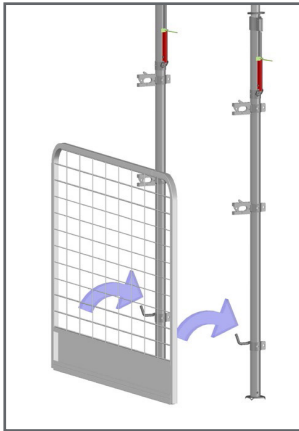

STEP 1: Place bottom of panel on to low hook.

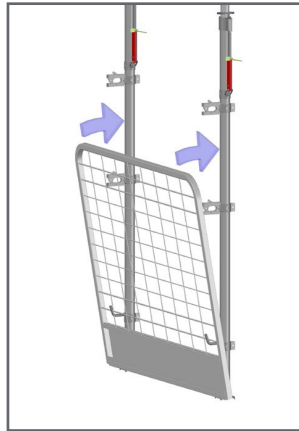

STEP 2: Place top of panel into latch.

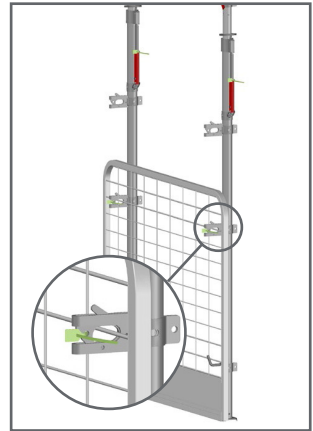

STEP 3: Secure latch with zip-tag (Optional).

Panel placement : DUAL PURPOSE STAND

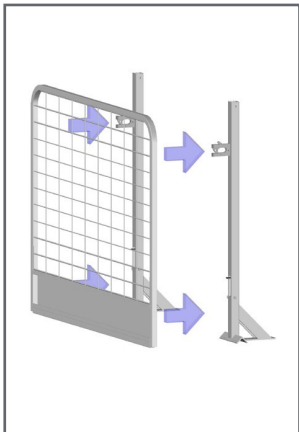

STEP 1: Place panel into latch.

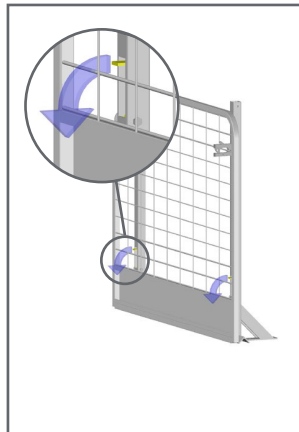

STEP 2: Drop post hook over bottom of panel.

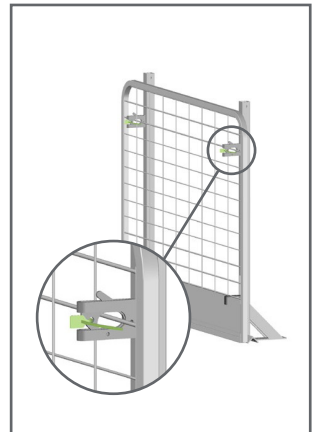

STEP 3: Secure latch with zip-tag (Optional).

SINGLE PANEL INSTALLATION GUIDE

IMPORTANT: Disassembly process must follow the instructions in reverse order. Improper installation or removal could result in serious injury or death.

Panel placement : STANDARD SUPPORT POST

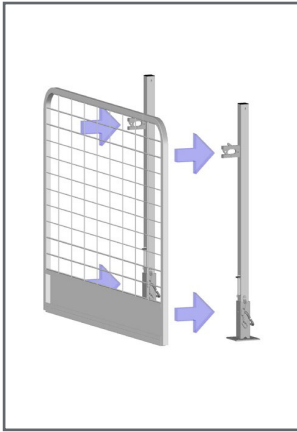

STEP 1: Place panel into latch.

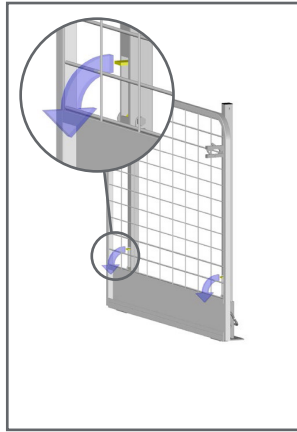

STEP 2: Drop post hook over bottom of panel.

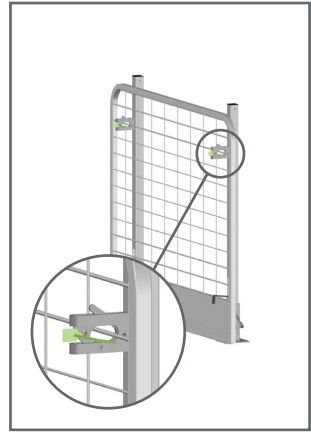

STEP 3: Secure latch with zip-tag (Optional).

Panel placement : STEEL FRAME POST

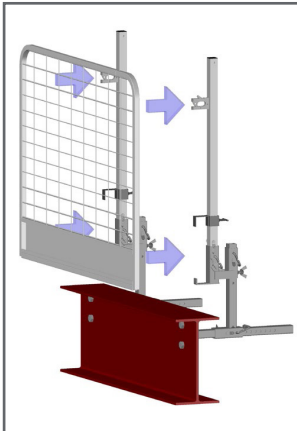

STEP 1: Place panel into latch.

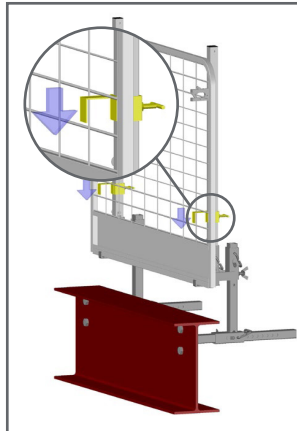

STEP 2: Lower post hook over panel.

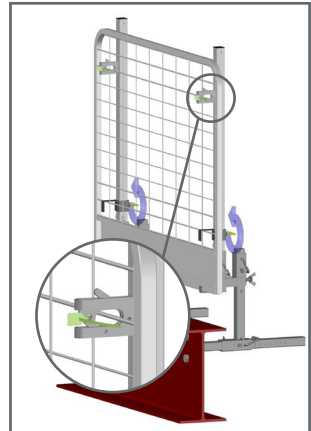

STEP 3: Secure latch with zip-tag (Optional).

DOUBLE HEIGHT INSTALLATION GUIDE

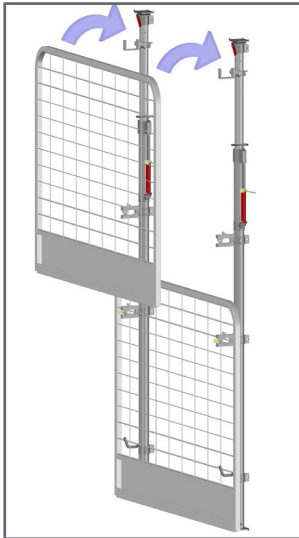

STEP 1: Place top of panel on to high hook.

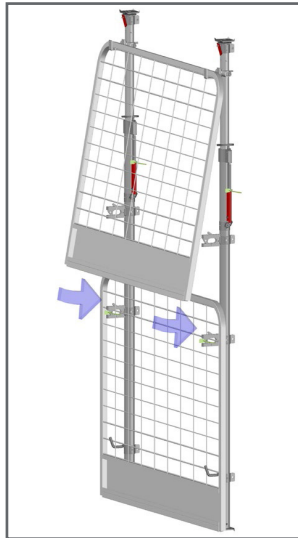

STEP 2: Place bottom of panel in to latch.

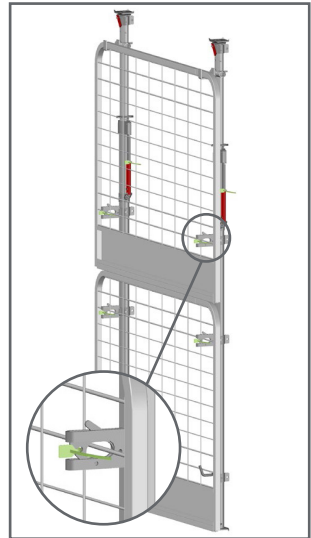

STEP 3: Secure latch with zip-tag (Optional).

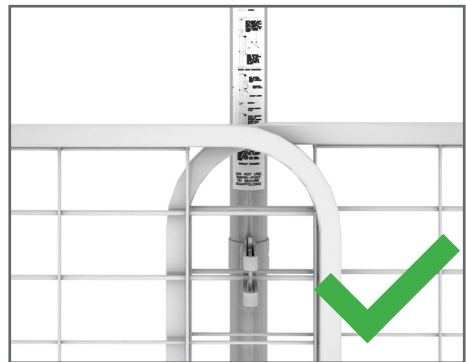
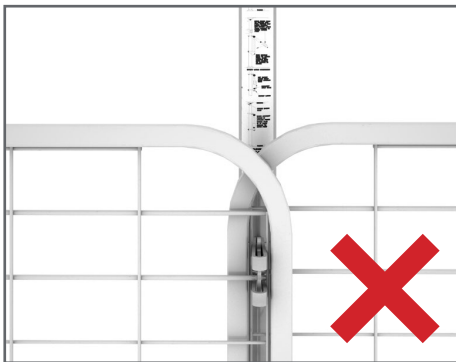

Panels **MUST** overlap by 1 full mesh aperture with maximum 2700mm/9'0" centres. (full panel).

IMPORTANT: Disassembly process must follow the instructions in reverse order.
Improper installation or removal could result in serious injury or death.

EP WORK THROUGH PANELS INSTALLATION GUIDE

450121
Half Panel
1400mm/4'7"
13.5kgs/29.76lbs

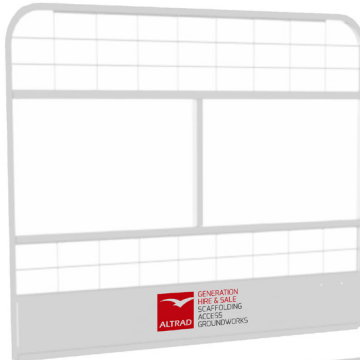

450111
Full Panel
2900mm/9'6"
26.5kgs/58.4lbs

SINGLE PANEL INSTALLATION GUIDE

For double height panels or higher, please see overleaf.

Panel placement : RAPID-POST & EXTRA



STEP 1: Place bottom of panel on to low hook.



STEP 2: Place top of panel into latch.

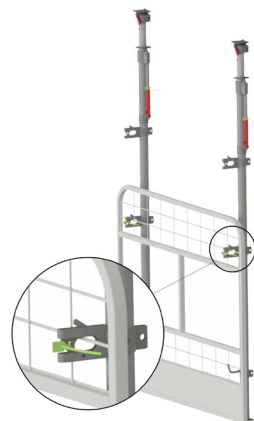

STEP 3: Secure latch with Zip-Tag. (Optional)

Panel placement : DUAL PURPOSE STAND

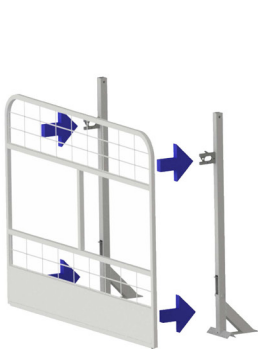

STEP 1: Place panel into latch.

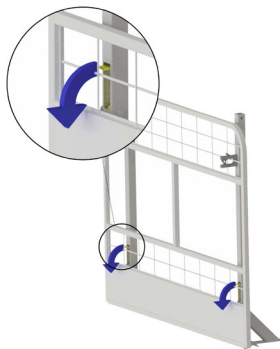

STEP 2: Drop post hook over bottom of panel.

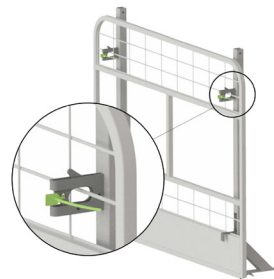

STEP 1: Secure latch with Zip-Tag. (Optional)

SINGLE PANEL INSTALLATION GUIDE

IMPORTANT: disassembly process must follow the instructions in reverse order.
improper installation or removal could result in serious injury or death.

Panel placement : STANDARD SUPPORT POST

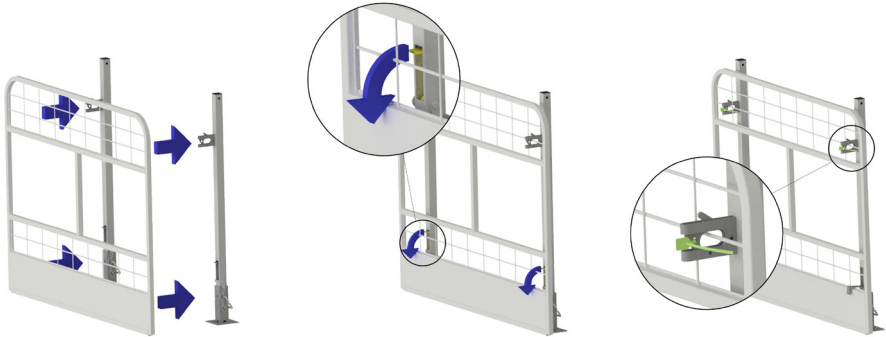

STEP 1: Place panel into latch.

STEP 2: Drop post hook over bottom of panel.

STEP 3: Secure latch with Zip-Tag. (Optional)

Panel placement : STEEL FRAME POST

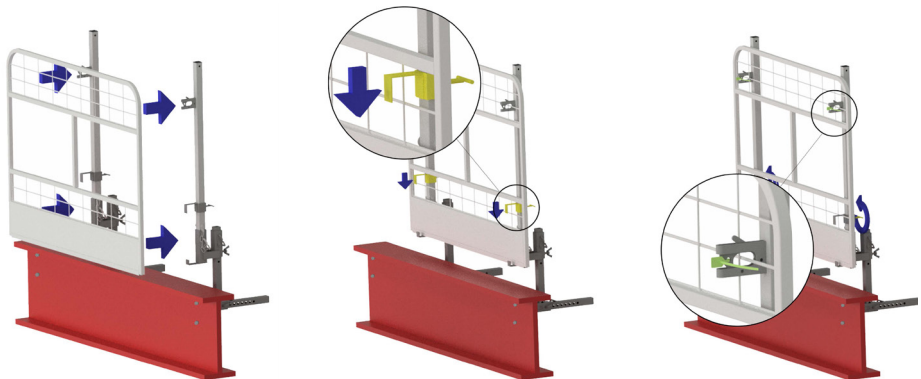

STEP 1: Place panel into latch.

STEP 2: Lower post hook over panel.

STEP 1: Secure latch with Zip-Tag. (Optional)

DOUBLE HEIGHT INSTALLATION GUIDE

For double height or higher, ep latches and ep clamps must first be installed on rapid posts, see rapid latch and rapid clamp installation guide.



STEP 1: Place top of panel on to high hook.



STEP 2: Place bottom of panel in to latch.

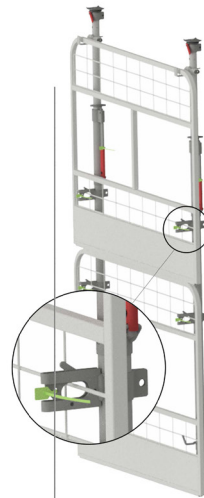

STEP 3: Secure latch with Zip-Tag. (Optional)

Panel Continuation : OVERLAP

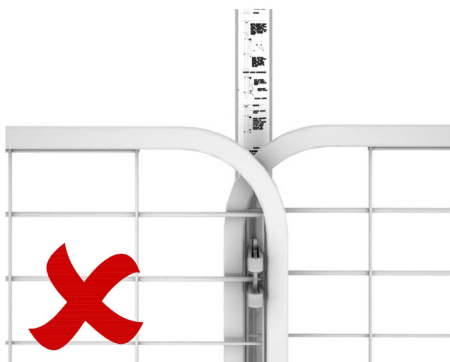

NOTES

Hire and Sale Branches Freephone:

0800 779 7113**Birmingham (West)**

Trinity Street Off Tat Bank Road,
Oldbury, West Midlands, B69 4LA
T: 0121 544 3355 F: 0121 544 3131
E: birmingham@generationuk.co.uk

Birmingham (East) G

87-93 Amington Road, Birmingham,
West Midlands, B25 8ET
T: 0121 706 0000 F: 0121 706 9832
E: birminghameast@generationuk.co.uk

Bristol

Unit 7, 12-16 Foundry Lane, Fishponds,
Bristol, B5 7UE
T: 0117 972 4550 F: 0117 972 4502
E: bristol@generationuk.co.uk

Cardiff

Martin Road, Tremorfa Industrial Estate
Cardiff, CF24 5SD
T: 029 2046 3835 F: 029 2046 3246
E: cardiff@generationuk.co.uk

Edinburgh

4 Westerton Road,
East Mains Industrial Estate, Broxburn,
West Lothian, EH52 5AU
T: 01506 863 864 F: 01506 863 916
E: edinburgh@generationuk.co.uk

Frimley (West London)

22-30 Sturt Road, Frimley Green
Camberley, GU16 6HY
T: 01252 838 696 F: 01252 837 614
E: frimley@generationuk.co.uk

Gateshead G

Stoneygate Lane, Abbotsford Road,
Felling, Gateshead, NE10 0EX
T: 0191 469 7504 F: 0191 469 8237
E: gateshead@generationuk.co.uk

Glasgow

Duchess Road, Rutherglen
Glasgow, G73 1AU
T: 0141 647 6969 F: 0141 647 5851
E: glasgow@generationuk.co.uk

Grays G

Europa Business Park, Magnet Road,
Grays, Essex, RM20 4DB
T: 01375 312 120 F: 01375 386 844
E: grays@generationuk.co.uk

Leeds

Unit 2 Ledger Park, Haigh Park Road,
Stourton, Leeds LS10 1RT
T: 0113 277 8822 F: 0113 277 7545
E: leeds@generationuk.co.uk

London (East)

Unit H, Hangman's Wood Ind Park,
Stifford Road, South Ockendon,
Essex, RM15 6RL
T: 020 7473 6056 F: 01708 858 493
E: london@generationuk.co.uk

Newcastle

Forward House, Portobello Road
Portobello Industrial Estate, Birtley,
Tyne and Wear, DH3 2SN
T: 0191 492 1190 F: 0191 411 1148
E: newcastle@generationuk.co.uk

Northampton

Kingsfield Way, Dallington,
Northampton, NN5 7QN
T: 01604 580 444 F: 01604 580 487
E: northampton@generationuk.co.uk

Salsburgh G

Duntilland Road, Shotts, Salsburgh,
North Lanarkshire, ML7 4NZ
T: 01698 870 200 F: 01698 870 159
E: salsburgh@generationuk.co.uk

Stockport

Unit 4 Vauxhall Industrial Estate,
Greg Street, Reddish,
Stockport, SK5 7BR
T: 0161 477 0131 F: 0161 477 7618
E: stockport@generationuk.co.uk

West Thurrock (East London)

4 Riverside Ind. Park, Oliver Road,
West Thurrock, RM20 3ED
T: 020 7476 4760 F: 020 7476 3157
E: westthurrock@generationuk.co.uk

Widnes G

Pitt Street, West Bank, Widnes,
Cheshire, WA8 0TG
T: 0151 420 3331 F: 0151 495 2298
E: widnes@generationuk.co.uk

Altrad Training Services

Unit 20B Greens Industrial Park,
Calder Vale Road, Wakefield, WF1 5PH
T: 01924 370 640 F: 01924 377 530
Freephone: 0800 587 5224
E: training@altraduk.co.uk

Generation Export

Trinity Street, Off Tat Bank Road
Oldbury, West Midlands, B69 4LA
T: +44 (0) 121 543 2964
E: export@generationuk.co.uk

Generation UK Head Office

Trinity Street, Off Tat Bank Road
Oldbury, West Midlands, B69 4LA
T: 0121 543 2950 F: 0121 543 2953
E: enquiries@generationuk.co.uk

G GROUNDWORKS

GENERATION UK Ltd
Generation Head Office, Trinity Street, Off Tat Bank Road, Oldbury, West Midlands, B69 4LA - United Kingdom
Tel. 0121 543 2950 - Fax. 0121 543 2953 - enquiries@generationuk.co.uk
www.generationuk.co.uk